

Rosemount 2090F Sanitary Pressure Transmitter with HART[®] Protocol

- *Conforms to 3-A[®] Sanitary Standards*
- *Features CIP/SIP service for process temperatures up to 284 ° F (140 ° C)*
- *Absolute or gage pressure ranges from 0-1.5 to 0-300 psi*
- *Mounts with either 1½- or 2-in. Tri-Clamp[®] connection*
- *Utilizes single-filled sensor system for reliability and outstanding accuracy*

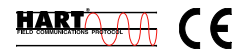

Contents

Specifications	page 3
Product Certifications	page 4
Dimensional Drawings	page 6
Ordering Information	page 7

Accurate, stable, and reliable pressure measurements for the Pharmaceutical and Food and Beverage Industry

Conforms to 3-A Sanitary Standards

The 2090F is a microprocessor-based Smart pressure transmitter that conforms to 3-A Sanitary Standards. The sanitary design also provides a product contact surface that is easy to clean and able to withstand thermal shocks.

Features CIP/SIP service with an upper temperature limit of 284 °F (140 °C)

The 2090F provides accurate, stable, and reliable pressure measurement, which makes it an ideal choice for pharmaceutical and food and beverage applications, including CIP/SIP service for process temperatures up to 284 °F (140 °C).

Absolute or Gauge pressure ranges from 0-1.5 to 0-300 psi and 20:1 turndown

Higher turndown allows for lower inventories by allowing you to measure pressures from 1.5 psi to 300 psi with only three transmitter ranges.

Mounts with either 1 1/2-in or 2-in. Tri-Clamp Connection

The 2090F is available with both 1 1/2-in. and 2-in. Tri-Clamp process connections, designed for sanitary applications to easily connect to standard sanitary fittings without requiring special mounting hardware.

Utilizes single-filled sensor system for reliability and outstanding accuracy

The 2090F sensor has a single-filled system with Neobee M-20 fill fluid which is approved as an indirect food additive according to the FDA. Its benefits include reliability, low oil fill for less temperature effect, and outstanding accuracy due to full sensor compensation.

Rosemount Pressure Solutions

Rosemount 3051S Series of Instrumentation

Scalable pressure, flow and level measurement solutions improve installation and maintenance practices.

Rosemount 3095 MultiVariable™ Mass Flow Transmitter

Accurately measures differential pressure, static pressure and process temperature to dynamically calculate fully compensated mass flow.

Rosemount 304, 305, and 306 Integral Manifolds

Factory-assembled, calibrated and seal-tested manifolds reduce on-site installation costs.

Rosemount 1199 Diaphragm Seals

Provides reliable, remote measurements of process pressure and protects the transmitter from hot, corrosive, or viscous fluids.

Annubar Flowmeter Series: Rosemount 3051SFA, 3095MFA, and 485

The state-of-the-art, fifth generation Rosemount 485 Annubar combined with the 3051S or 3095MV MultiVariable transmitter creates an accurate, repeatable and dependable insertion-type flowmeter.

Compact Orifice Flowmeter Series: Rosemount 3051SFC, 3095MFC, and 405

Compact Orifice Flowmeters can be installed between existing flanges, up to a Class 600 (PN100) rating. In tight fit applications, a conditioning orifice plate version is available, requiring only two diameters of straight run upstream.

Integral Orifice Flowmeter Series: Rosemount 3051SFP, 3095MFP, and 1195

These integral orifice flowmeters eliminate the inaccuracies that become more pronounced in small orifice line installations. The completely assembled, ready to install flowmeters reduce cost and simplify installation.

Orifice Plate Primary Element Systems: Rosemount 1495 and 1595 Orifice Plates, 1496 Flange Unions and 1497 Meter Sections

A comprehensive offering of orifice plates, flange unions and meter sections that is easy to specify and order. The 1595 Conditioning Orifice provides superior performance in tight fit applications.

Specifications

Functional Specifications

Service

Liquid, gas, vapor, and high-viscosity applications

Ranges

Range	Minimum Span	URL/Max. Span Sensor Limit
1	1.5 psi (103 mbar)	30 psi (2,06 bar)
2	7.5 psi (517 mbar)	150 psi (10,34 bar)
3	40 psi (2,76 bar)	300 psi (20,68 bar)

Output

4–20 mA dc/Digital HART Protocol

Load Limitations

Maximum loop resistance is determined by the power supply voltage, as described by the following equation:

$$\text{Max. Loop Resistance} = 43.5 \frac{(\text{Power Supply Voltage} - 10.5)}{}$$

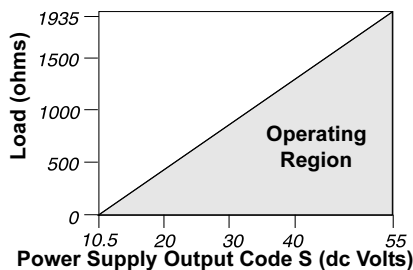

(1) For hazardous location approvals, power supply must not exceed 36 V.

Power Supply

External power supply required. Transmitter operates on 10.5–36 V dc with no load. Reverse polarity protection is standard.

Zero Elevation and Suppression

Zero can be suppressed between atmosphere (2090FG), or 0 psia (2090FA) and upper range limit, if the calibrated span is equal to or greater than the minimum span, and the upper range value does not exceed the upper range limit. No vacuum calibrations are allowed on the 2090F.

Overpressure Limits

Range 1: 120 psig max
All other ranges: Twice the upper range limit

Temperature Limits

Process
–4 to 284 °F (–20 to 140 °C)

Ambient

–4 to 185 °F (–20 to 85 °C)

Storage

–22 to 185 °F (–30 to 85 °C)

Process temperatures above 185 °F (85 °C) require lowering the ambient limits by a 1.5:1 ratio:

$$\text{Max. Ambient temperature in } ^\circ\text{F} = \frac{185 - (\text{Process Temp} - 185)}{1.5}$$

$$\text{Max. Ambient temperature in } ^\circ\text{C} = \frac{85 - (\text{Process Temp} - 85)}{1.5}$$

Humidity Limits

0–100% relative humidity

Volumetric Displacement

Less than 0.00042 cm³

Turn-on Time

2.0 seconds, no warm-up required

Failure Alarm

If self-diagnostics detect a sensor or microprocessor failure, the analog signal is driven either high or low to alert the user. High or low failure mode is user-selectable by a jumper on the transmitter. The values to which the transmitter drives its output in failure mode depend on whether it is factory-configured to *standard* or *NAMUR-compliant* operation. The values for each are as follows:

Standard Operation

Linear Output: $3.9 \leq I \leq 20.8$
Fail High: $I \geq 21.75$ mA
Low: $I \leq 3.75$ mA

NAMUR-Compliant Operation

Linear Output: $3.8 \leq I \leq 20.5$
Fail High: $I \geq 22.5$ mA
Low: $I \leq 3.6$ mA

Transmitter Security

Activating the transmitter security function prevents changes to the transmitter configuration, including local zero and span adjustments. Security is activated by an internal jumper.

Rosemount 2090F

Performance Specifications

(Zero-based spans, reference conditions, and 316 SST isolating diaphragm.)

Reference Accuracy

±0.20% of calibrated span. Includes combined effects of linearity, hysteresis, and repeatability.

Ambient Temperature Effect per 100 °F (56 °C)

±(0.3% URL + 0.3% of span) from -40 to 185 °F (-40 to 85 °C)

Stability

±0.10% of upper range limit for 12 months

Time Response

Less than 200 ms time constant (63.2% response to a step change in pressure)

Vibration Effect

Less than ±0.1% of upper range limit when subjected to vibration of peak to peak constant displacement of 4 mm (5–15 Hz) and constant acceleration of 2 g (15–150 Hz) and 1 g (150–2000 Hz).

Power Supply Effect

Less than 0.01% of calibrated span per volt

Mounting Position Effect

Zero shift of up to 1.2 inH₂O (0.3 kPa), which can be calibrated out. No span effect

RFI Effect

Less than ±0.25% of upper range limit from 20–1000 MHz at 30 V/m with leads in conduit. Less than ±0.25% of upper range limit from 20–1000 MHz at 10 V/m with unshielded twisted pair (no conduit).

Physical Specifications

Electrical Connection

¹/₂-14 NPT, PG 13.5, or M20 × 1.5 (CM20) conduit entry.

Process Wetted Parts

Isolating Diaphragm

316L stainless steel

Process Connector

316L stainless steel

Non-wetted Parts

Electronics Housing

Low-copper aluminum, NEMA 4X, IP65, IP67, CSA enclosure Type 4X

Paint

Polyurethane

Cover O-rings

Buna-N

Product Certifications

Approved Manufacturing Locations

Rosemount Inc. — Chanhassen, Minnesota, USA
Emerson Process Management GmbH & Co. — Wessling, Germany
Emerson Process Management Asia Pacific Private Limited — Singapore
Beijing Rosemount Far East Instrument Co., LTD — Beijing, China

European Union Directive Information

The EC declaration of conformity for all applicable European directives for this product can be found on the Rosemount website at www.rosemount.com. A hard copy may be obtained by contacting our local sales office.

ATEX Directive (94/9/EC)

Emerson Process Management complies with the ATEX Directive.

European Pressure Equipment Directive (PED) (97/23/EC)
2088/2090 Pressure Transmitters
— Sound Engineering Practice

Electro Magnetic Compatibility (EMC) (2004/108/EC)
All 2088/2090 Smart Pressure Transmitter:
EN 61326-1:1997 with Amendments A1, A2, and A3

Ordinary Location Certification for Factory Mutual

As standard, the transmitter has been examined and tested to determine that the design meets basic electrical, mechanical, and fire protection requirements by FM, a nationally recognized testing laboratory (NRTL) as accredited by the Federal Occupational Safety and Health Administration (OSHA).

Hazardous Locations Certifications

North American Certifications

Factory Mutual (FM) Approvals

- E5** Explosion-Proof for Class I, Division 1, Groups B, C, and D. Dust-Ignition-Proof for Class II, Division 1, Groups E, F, G, Class III, Division 1, indoor and outdoor (NEMA 4X) hazardous locations; factory sealed.
- I5** Intrinsically safe for use in Class I, Division 1, Groups A, B, C, D; Class II, Division 1, Groups E, F, and G; and Class III, Division 1 when connected in accordance with Rosemount drawing 02088-1018. Non-incendive for Class I, Division 2, Groups A, B, C, and D. For input parameters see control drawing 02088-1018.

Canadian Standards Association (CSA)

- C6** Explosion-Proof for Class I, Division 1, Groups B, C, and D. Dust-Ignition-Proof for Class II, Division 1, Groups E, F, G, Class III, indoor and outdoor hazardous locations. CSA enclosure Type 4X; factory sealed. Suitable for Class I, Division 2, Groups A, B, C, and D. Intrinsically Safe for Class I, Division 1, Groups A, B, C, and D. Temp. Code T3C. Intrinsically safe when connected with approved barriers in accordance with Rosemount drawing 02088-1024. For input parameters see control drawing 02088-1024.

European Certifications



- I1** ATEX Intrinsic Safety
Certificate No.: BAS00ATEX1166X  II 1 G
EEx ia IIC T5 (T_{amb} = -55 to 40 °C)
EEx ia IIC T4 (T_{amb} = -55 to 70 °C)
CE 1180

TABLE 1. Input Parameters

Loop/Power	Input Type
U _i = 30 V dc	Smart
I _i = 200 mA	Smart
P _i = 0.9 W	Smart
C _i = 0.012 μF	Smart

Special Conditions for Safe Use (x):

When the optional transient protection terminal block is installed, the apparatus is not capable of withstanding a 500V rms test to case. This must be taken into account on any installation in which it is used, for example by assuring that the supply to the apparatus is galvanically isolated.

- N1** ATEX Type n
Certificate No.: BAS00ATEX3167X  II 3 G
EEx nL IIC T5 (T_a = -40 °C to 70 °C)
U_i = 50 V dc max
CE

Special Conditions for Safe Use (x):

When the optional transient protection terminal block is installed, the apparatus is not capable of withstanding a 500 V r.m.s. test to case. This must be taken into account on any installation in which it is used, for example, by assuring that the supply to the apparatus is galvanically isolated.

- ND** ATEX Combustible Dust
Certificate No.: BAS01ATEX1427X  II 1 D
T105°C (T_{amb} = -20°C to 85°C)
IP66
CE 1180
V_{max} = 36 V dc Max
I_i - 24 mA

Special Conditions for Safe Use (x):

1. The user must ensure that the maximum rated voltage and current (36 volts, 24 mA, D.C.) are not exceeded. All connections to other apparatus or associated apparatus shall have control over this voltage and current equivalent to a category "ib" circuit according to EN50020.
2. Cable entries must be used which maintain the ingress protection of the enclosure to at least IP66.
3. Unused cable entries must be filled with suitable blanking plugs which maintain the ingress protection of the enclosure to at least IP66.
4. Cable entries and blanking plugs must be suitable for the ambient range of the apparatus and capable of withstanding a 7J impact test.
5. The 2088/2090 sensor module must be securely screwed in place to maintain the ingress protection of the enclosure.

- ED** ATEX Flameproof
Certification No.: KEMA97ATEX2378  II 1/2 G
EEx d IIC T6 (T_a = -20 °C to 40°C)
T4 (T_a = -20 °C to 80 °C)
CE 1180
V_{max} = 36 (with Smart output option)
V_{max} = 14 (with low power output option)

Japanese Certifications

- E4** TIIS Flame-Proof
Ex d IIC T6 (T_{amb} = 85 °C)

Certificate	Description
C15870	2090F with SST wetted parts (with meter)
C15878	2090F with SST wetted parts (no meter)

Combinations of Certifications

Stainless steel certification tag is provided when optional approval is specified. Once a device labeled with multiple approval types is installed, it should not be reinstalled using any other approval types. Permanently mark the approval label to distinguish it from unused approval types.

- KB** Combination of E5, I5, and C6
- KH** Combination of E5, I5 and I1
- K5** Combination of E5 and I5
- K6** Combination of C6, I1, and ED

Dimensional Drawings

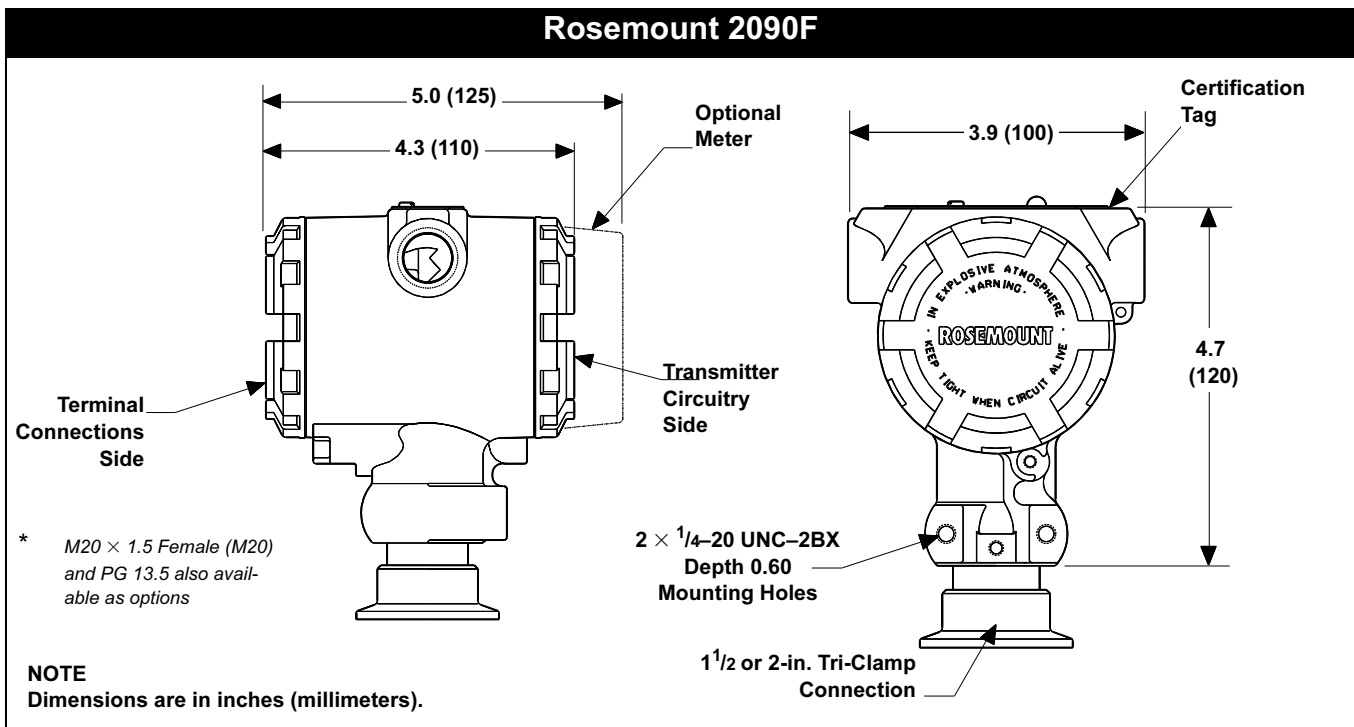
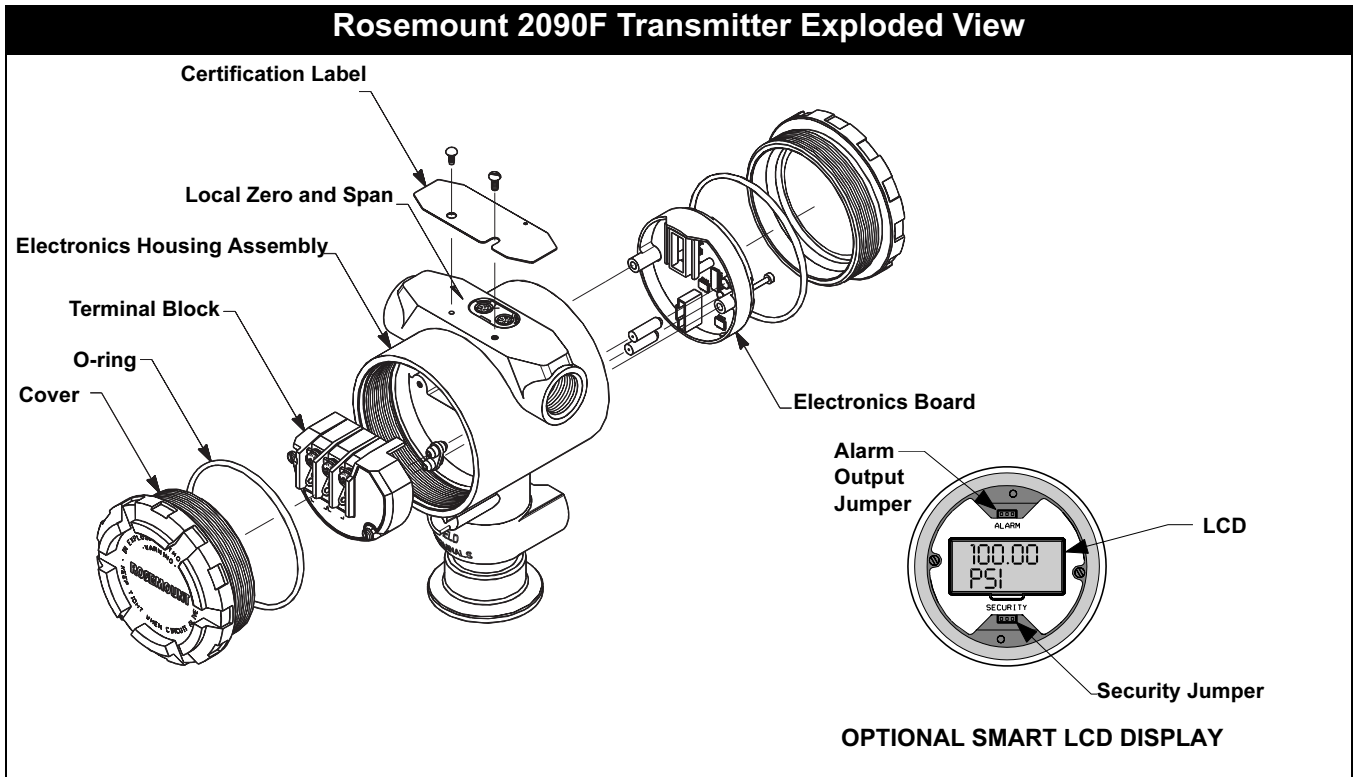

Ordering Information

Model	Product Description		
2090F	Sanitary Pressure Transmitter		
Code	Transmitter Type		
A	Absolute		
G	Gage		
Code	Range	Minimum Span	URL/Max. Span Sensor Limit
1	0–30 psi (0–2 bar)	1.5 psi (103 mbar)	30 psi (2,06 bar)
2	0–150 psi (0–10.3 bar)	7.5 psi (517 mbar)	150 psi (10,34 bar)
3	0–300 psi (0–20.7 bar)	40 psi (2,76 bar)	300 psi (20,68 bar)
Code	Output		
S	4–20 mA dc/Digital HART Protocol		
Code	Material of Construction		
	Process Connection	Isolating Diaphragm	Oil Fill
2D	316L SST	316L SST	Neobee
Code	Process Connection		
E	1 ¹ / ₂ -in. <i>Tri-Clamp</i> Connection		
F	2-in. <i>Tri-Clamp</i> Connection		
Code	Conduit Thread		
1	1 ¹ / ₂ -14 NPT		
2	M20 × 1.5 (CM 20)		
3	PG 13.5		
Code	Options		
Digital Display			
M5	LCD display, scaled 0-100%		
M7	LCD display, special configuration		
Mounting Brackets			
B4	SST mounting bracket with SST Bolts		
Product Certifications			
I1	ATEX Intrinsic Safety		
N1	ATEX Type n		
ND	ATEX Dust		
ED	ATEX Flameproof		
C6	CSA Explosion-Proof, Intrinsically Safe, and Non-incendive		
K6	CSA Explosion-Proof, Dust Ignition-proof, Intrinsically Safe, Division 2		
E5	FM Explosion-Proof, Dust Ignition-proof		
I5	FM Intrinsically safe, Division2		
K5	FM Explosion-Proof, Dust Ignition-proof, Intrinsically Safe, Division 2		
KB	FM and CSA Explosion-Proof, Dust Ignition-proof, Intrinsically Safe, Division 2		
KH	FM Approvals and ATEX Explosion-Proof and Intrinsically Safe		
NK	IECEx Dust		
K7	I7, N7, E7 & NK Combination		
K1	I1, N1, ED & ND Combination		
Terminal Blocks			
T1	Transient Protection		
Special Certifications			
Q4	Calibration Certificate		
Special Configuration (Software)			
C4	NAMUR alarm and saturation levels, high alarm		
CN	NAMUR alarm and saturation levels, low alarm		
Special Procedures			
P2	Cleaning for Special Service		
P8	0.1% Accuracy to 10:1 Turndown		
Typical Model Number: 2090FG 2 S 2D E 1			

Rosemount 2090F

Calibration

Transmitters are factory calibrated to customer's specified range. If calibration is not specified, transmitters are calibrated at maximum range. Calibration is at ambient temperature and pressure.

Tagging

The transmitter will be tagged, at no charge, in accordance with customer requirements. All tags are stainless steel. The standard tag is wired to the transmitter. Tag character height is 1/8 inch (0.318 cm). A permanently attached tag is available upon request.

*Standard Terms and Conditions of Sale can be found at www.rosemount.com/terms_of_sale
The Emerson logo is a trade mark and service mark of Emerson Electric Co.
Rosemount and the Rosemount logotype are registered trademarks of Rosemount Inc.
Neobee is a registered trademark of Stepan Chemical Co.
Tri-Clamp is a registered trademark of Tri-Clover Inc. og the Alfa-Laval Group.
The 3-A symbol is a registered trademark of the 3-A Sanitary Standards Symbols Council.
All other marks are the property of their prospective owners.*

Cover Photo: 2090-0014AB
Emerson Process Management

Rosemount Inc.
8200 Market Boulevard
Chanhassen, MN 55317 USA
T (U.S.) 1 800 999 9307
T (International) (952) 906 8888
F (952) 949 7001

www.rosemount.com

Emerson Process Management	Emerson Process Management Asia
Heath Place	Pacific Private Limited
Bognor Regis	1 Pandan Crescent
West Sussex PO22 9SH	Singapore 128461
England	T (65) 6777 8211
T 44 (0) 1243 863121	F (65) 6777 0947
T 44 (0) 1243 867554	Enquiries@AP.EmersonProcess.com

